

EQUI8

Three-Phase Low Voltage Network Balancer

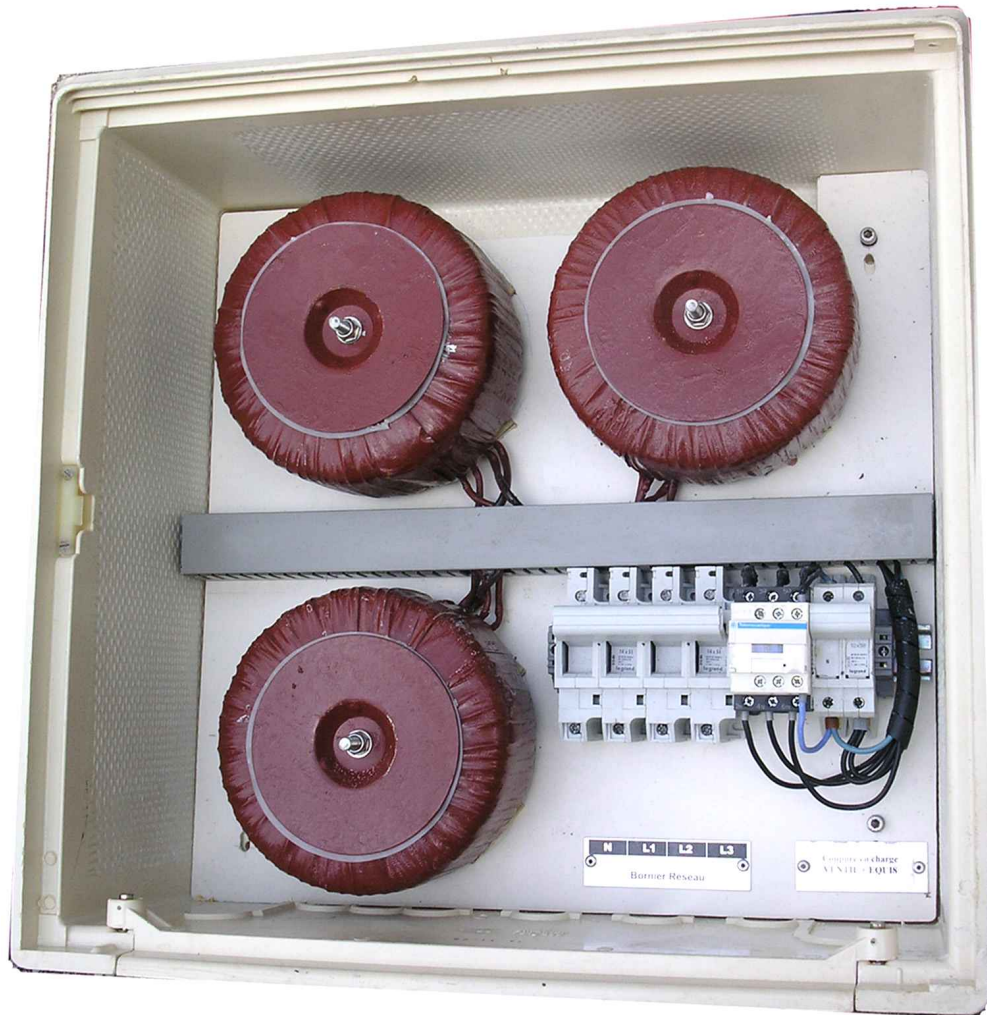

Installation Manual

Ref : NT-EQUI8 N°EN-A2 (May. 17th 2018)





	INSTALLATION MANUAL	N° NT	NT-EQUI8
	EQUI8	Version	EN-A2
	Three-Phase Low Voltage Network Balancer	Page	2/17

Table of Contents

I. EQUIPMENT PRESENTATION.....		3
A. Introduction		3
B. Schematic Diagram.....		3
C. How it works.....		4
D. Applications /Specifications.....		5
E. Protection and load break switch.....		6
F. Maintenance		6
II. CONNECTION TYPE TO THE NETWORK		6
III. INSTALLATION AND COMISSIONING.....		8
A. Installation on a pole.....		8
B. EQUI8 lifting safety instructions.....		12
C. EQUI8's installation on a pole.....		12
D. EQUI8's installation on a base.....		13
E. EQUI8's connection to the network.....		15
IV. How to change fuses.....		16
V. EQUI8's connection diagram.....		17

	INSTALLATION MANUAL	N° NT	NT-EQUI8
	EQUI8	Version	EN-A2
	<i>Three-Phase Low Voltage Network Balancer</i>	Page	3/17

I. EQUIPMENT PRESENTATION

A. Introduction

Single phase loads or power injection cause large voltage variations on LV networks with long lines. This affects voltage quality to an extent ranging from customer complaint to equipment damage. For distributed production, over voltage may force inverters disconnection and result in loss of production with associated contract issues.

EQUI8 is designed to be connected in parallel with the 3-phase 4-wire LV network at line weakest point. It creates a low impedance zero sequence path and diverts most of neutral current. This results in a much better phase balance in the upstream lines. Voltage variations due to the line resistance are typically reduced by a factor 2 to 3 (depending on the impedance of the network) thereby solving the issue.

It can be installed as a temporary solution when grid reinforcement is planned to match an expected growing demand (new customers) or as a fixed solution when the demand growth does not exceed EQUI8 balancing capacity.

Mainly based on 3 zigzag transformers, including no sensitive electronic, EQUI8 fits in a standard polymer enclosure. It can be either fixed on poles or on a standard base in case of a buried network. Its parallel mounting ensures continuity of supply even in the unlikely event of failure.

B. Schematic Diagram

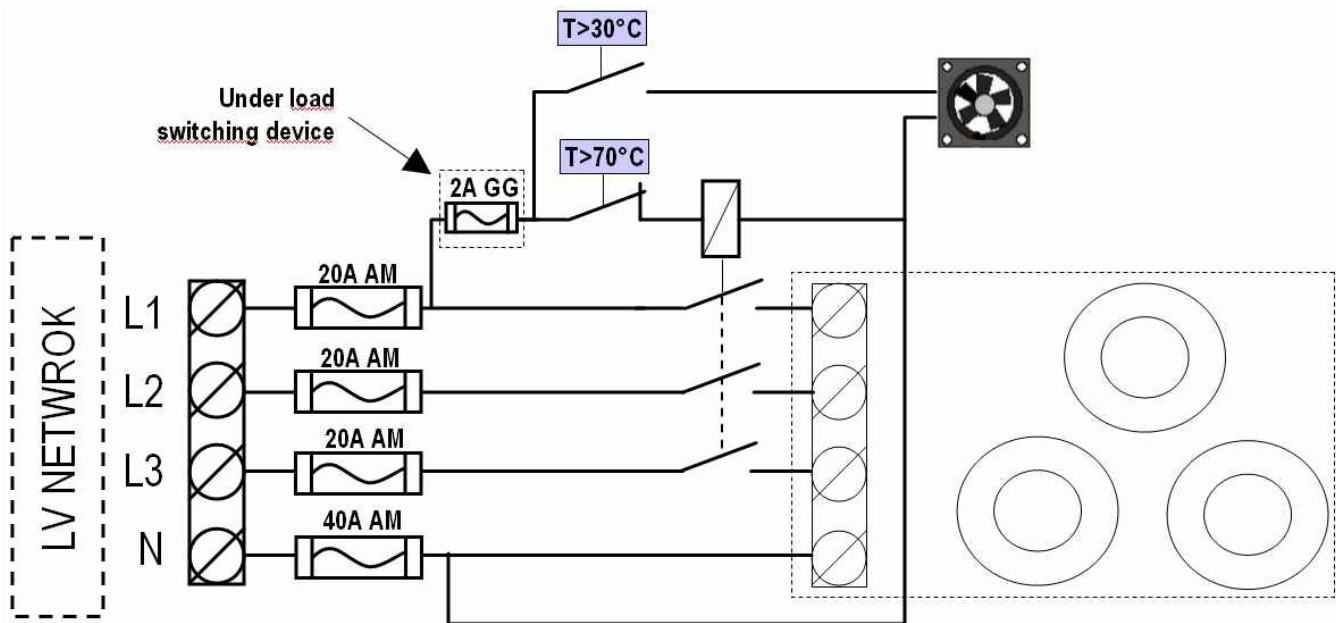

Class II insulated, EQUI8 does not have to be earth-grounded. When running under load, a fan is activated to stabilize inner temperature at 30°C. A security thermostat with automatic reset disconnects EQUI8 in case of overload (when T > 70 °C).

C. How it works

Considering a single-phase load applied on the network downstream of EQUI8 :

- a fraction F of the initial upstream neutral current will flow through the neutral line of EQUI8. Thereby, it will reduce the displacement of the neutral point towards the loaded phase.
- The upstream current on the loaded line is reduced by F/3 and an additional current of F/3 is applied upstream on the 2 remaining lines.

These two balancing effects cause a large reduction of the voltage drop and of the line losses. To be noticed : Fraction F and thereby the voltage drop reduction increases with the line length.

This process works equally for overvoltage due to single-phase distributed producers.

Moreover, one should notice that EQUI8 tends to balance the position of the neutral point even when the imbalance is caused by an upstream load or power injection or even can be observed already on the high voltage line. One should remember that balancing is optimized at EQUI8's connection point but also has an effect on the upstream voltage levels.

The next diagram presents a typical application of EQUI8 :

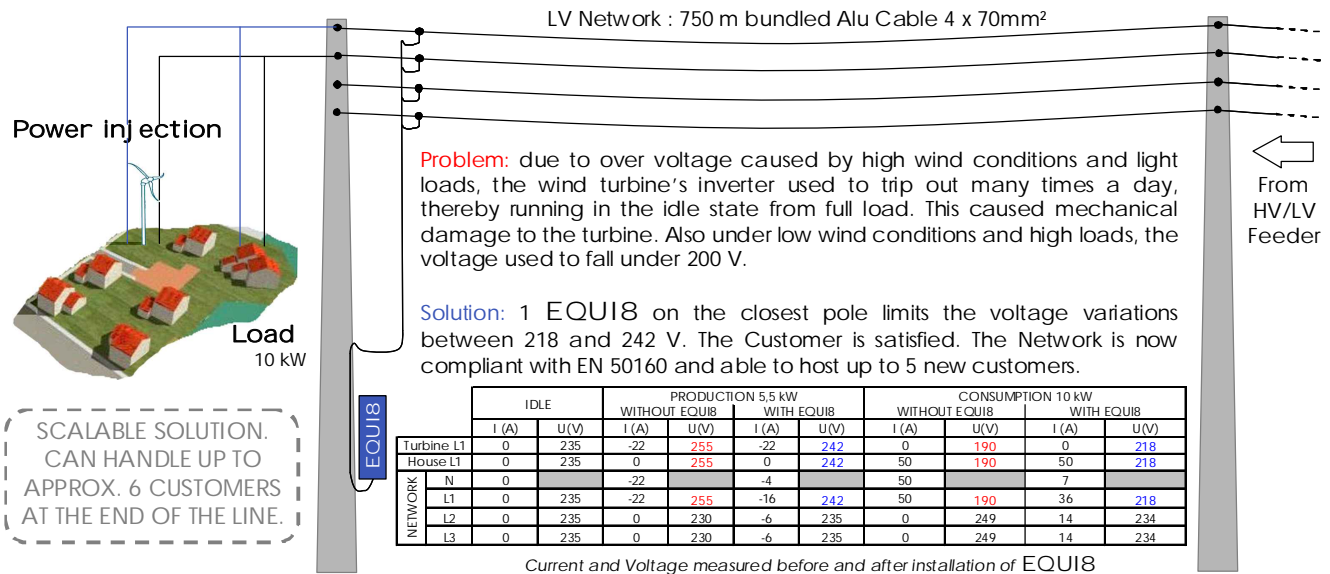

	INSTALLATION MANUAL	N° NT	NT-EQUI8
	EQUI8	Version	EN-A2
	<i>Three-Phase Low Voltage Network Balancer</i>	Page	5/17

D. Applications /Specifications

EQUI8 should only be used on impedant lines ($Z_{Phase} + Z_{Neutral} > 0.3$ Ohms. This corresponds to a 300 m long bundled Alu 70 mm² network).

EQUI8 is designed to divert continuously up to 45Amps from the neutral line. Short duration overloads are acceptable up to 60 Amps during 3 hours and 80 Amps during 15 minutes. For greater loads, it is possible to mount several EQUI8 in parallel along a line.

It is best suitable to be used on networks supplying at their end consumers with up to 50 kW subscribed power and/or Producers with up to 50 kW subscribed power. Prior to its installation, please use our online calculator to check the compliance of EQUI8 with your case to solve or contact us for a support study.

Detailed technical specifications of EQUI8 are given in the following table. Specifications are subject to change for improvement without notice.

Product Name	EQUI8
Nominal Current ($I_{neutral}$)	45 Amps
<i>Short duration Overload</i>	60 Amps 3 hours / 80 Amps 15 min.
Dimension (D x W x H)	21x54x55 cm
Weight	53 kg
Network	4-Wire, 3-Phase, 400 V between lines
Frequency	50Hz
Enclosure Ingress Protection	IP34D
Inner components Ingress Protection	IP2X
Insulation Class	Class II
Efficiency	97.7% under full load Idle power < 25 W
Enclosure mechanical Protection	IK10
Working Temperature	-40 to 70 °C
Humidity	0 to 100%RH
Salt Mist Withstand	Essai Ka (EN 60068-2-11)
Expected lifespan	30 years

	INSTALLATION MANUAL	N° NT	NT-EQUI8
	EQUI8	Version	EN-A2
	<i>Three-Phase Low Voltage Network Balancer</i>	Page	6/17

E. Protection and load break switch

EQUI8 is protected from overloads from main by fuses :

Phase	3 cartridge fuses 14x51 - 20 amp type AM
Neutral	1 cartridge fuse 14x51 - 40 amp type AM

To connect or disconnect EQUI8 under load, use the 1P+N fuse holder marked "VENTIL+EQUI8". It feeds the air-fan and the 3-Phase relay on which the three zigzag transformers are connected. It is protected by 1 cartridge fuse 10x38 - 2 A type GG.

F. Maintenance

EQUI8 requires no preventive maintenance.

After any incident on the LV network (in particular if one of the 3 phase cable is broken), check if EQUI8 is still fed by the network (cartridge fuses need to be checked – see page 16).

II. CONNECTION TYPE TO THE NETWORK

EQUI8 is designed to be connected in parallel with aerial and buried LV networks.

Cable sections and types for EQUI8's connection to the network

	# of cables	Type	Section
Network to EQUI8	3P+N	Bundled Alu* or Copper	25 mm ²

* : For Alu cables, the use of Insulation piercing end connector type EBCP35M-16 is compulsory.



(available at <http://www.michaud-export.com/products/residential-electrical-distribution/wiring-accessories/insulation-piercing-end-connector.html> ; Ref P 446 and P447)

Standard connection schemes :

CONNECTION ON AN AERIAL NETWORK

INITIAL

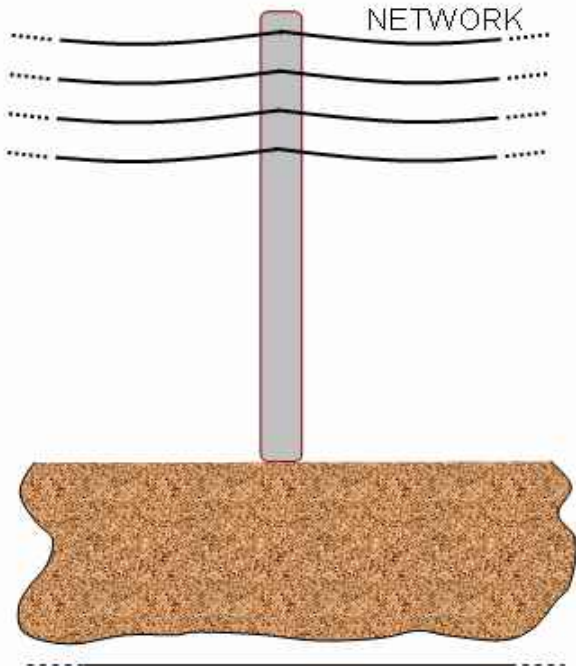

WITH EQUI8

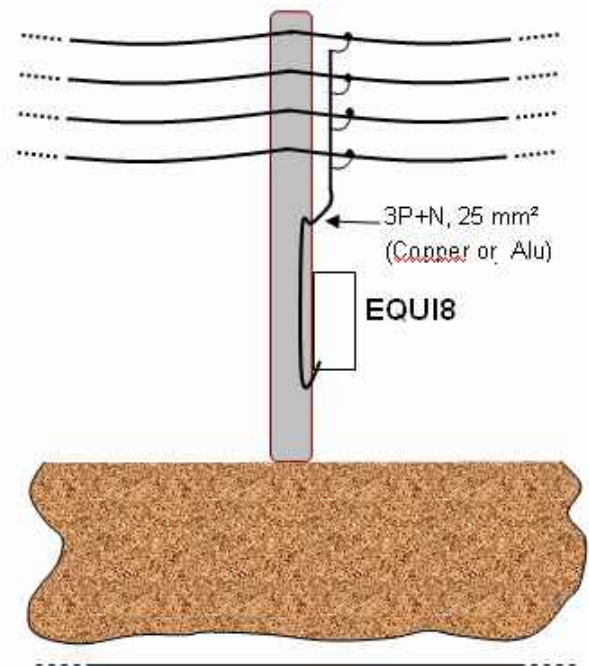

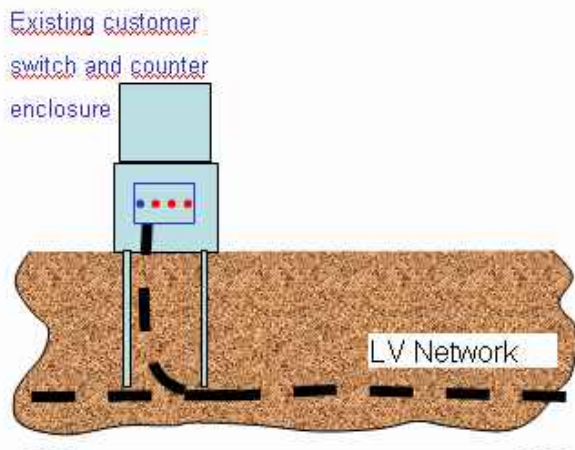

CONNECTION ON A BURIED NETWORK

INITIAL

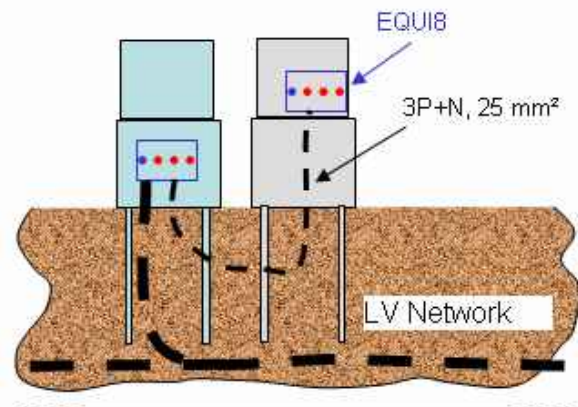

WITH EQUI8



	<h1>INSTALLATION MANUAL</h1>	N° NT	NT-EQUI8
	<h2>EQUI8</h2>	Version	EN-A2
	<i>Three-Phase Low Voltage Network Balancer</i>	Page	8/17

III. INSTALLATION AND COMISSIONING

A. Installation on a pole

The standard mounting kit supplied with EQUI8 enables installation on rectangular section poles.

It includes :

- ① : 1 supporting frontbeam
- ② : 2 side beams (U Profile with notches for the supporting front beam and multiple holes for the threaded rods)
- ③ : 2 threaded rods M12 L500 mm (to fasten the side beams on the pole)
- ④ et ⑤ : 4 M12 washers and 8 M12 nuts

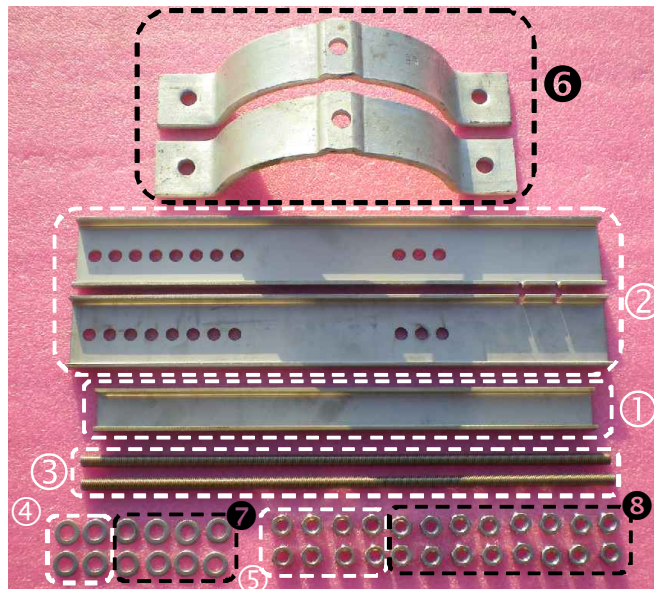

In option, an adaptation kit for circular section wooden poles is available.

It includes :

- ⑥ : Mounting brackets (size available for different pole diameters : D160, D180, D200, D220, D240, D260 mm)
- ⑦ et ⑧ : 8 M12 washers and 16 M12 nuts

Mounting Kit compatible poles :

- Rectangular section :
 - o EQUI8 backside : max width = 410 mm
 - o Side beams side : $140 < \text{width} < 285$ mm
- Circular section :
 - o $160 \text{ mm} < \text{diameter} < 260$ mm

	INSTALLATION MANUAL	N° NT	NT-EQUI8
	EQUI8	Version	EN-A2
	<i>Three-Phase Low Voltage Network Balancer</i>	Page	9/17

Installation on a rectangular section pole

To ensure stability to EQUI8, use the hole marked in red in the scheme underneath to put the front threaded rod through. At the back of the pole, use the closest hole to the pole for the second threaded rod.

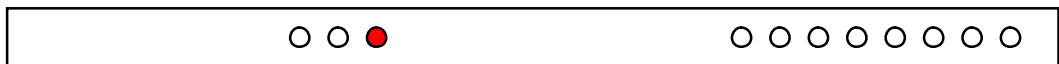

Front View



Back View



Side View



Safety Instructions :

1. Nuts should be tightened enough to lock the beams on the pole without distorting the beams themselves.
2. Use the additional 4 nuts as locking nuts.
3. Saw off the threaded rod tips at locking nut ends.

	INSTALLATION MANUAL	N° NT	NT-EQUI8
	EQUI8	Version	EN-A2
	Three-Phase Low Voltage Network Balancer	Page	10/17

Installation on a circular section pole

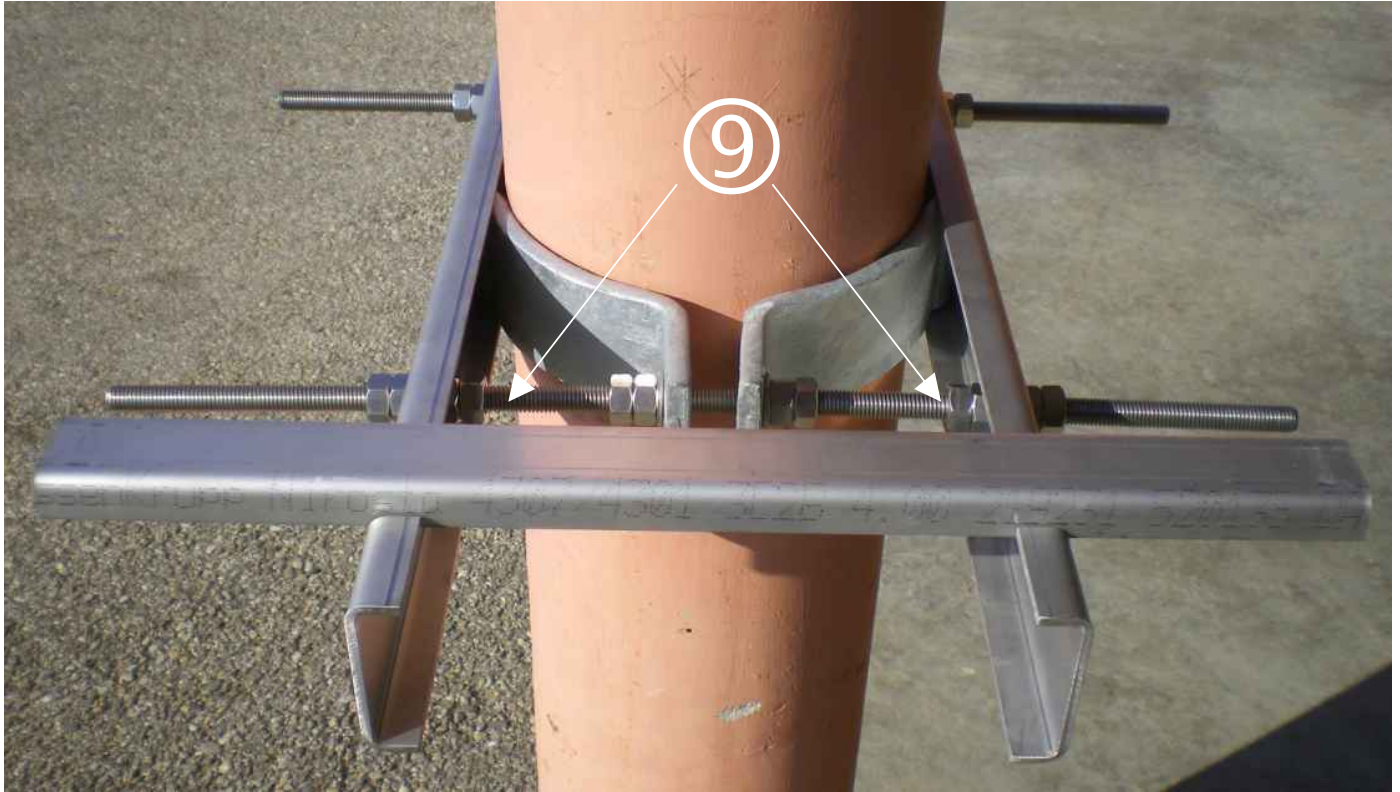

Safety instructions :

1. Install the mounting brackets using the 2 threaded rods, 4 washers and 4 nuts. Make sure the brackets are locked on the pole. Then lock the 4 nuts using 4 nuts as locking nuts.
2. Install 4 "nuts-locking nuts" couples on each outer side of the 2 threaded rods (see position ⑨ on the picture above), so that the inner base part of the U Profile side beams leans on the "nuts-locking nuts" couples and that the upper parts of the U Profile side beams leans on the pole. As shown on the picture above, the mounting brackets fit actually inside the U Profile side beams.
3. Fasten the U Profile side beams using 4 washers, 4 nuts and 4 nuts as locking nuts.
4. Saw off the threaded rod tips at locking nut ends.

	INSTALLATION MANUAL	N° NT	NT-EQUI8
	EQUI8	Version	EN-A2
	Three-Phase Low Voltage Network Balancer	Page	11/17

Installation on a circular section pole : which holes should be used on the U profile side beams for the threaded rods ?

To ensure stability to EQUI8, use the hole marked in red in the scheme underneath to threaded rods through. Positions depend on the pole diameter :

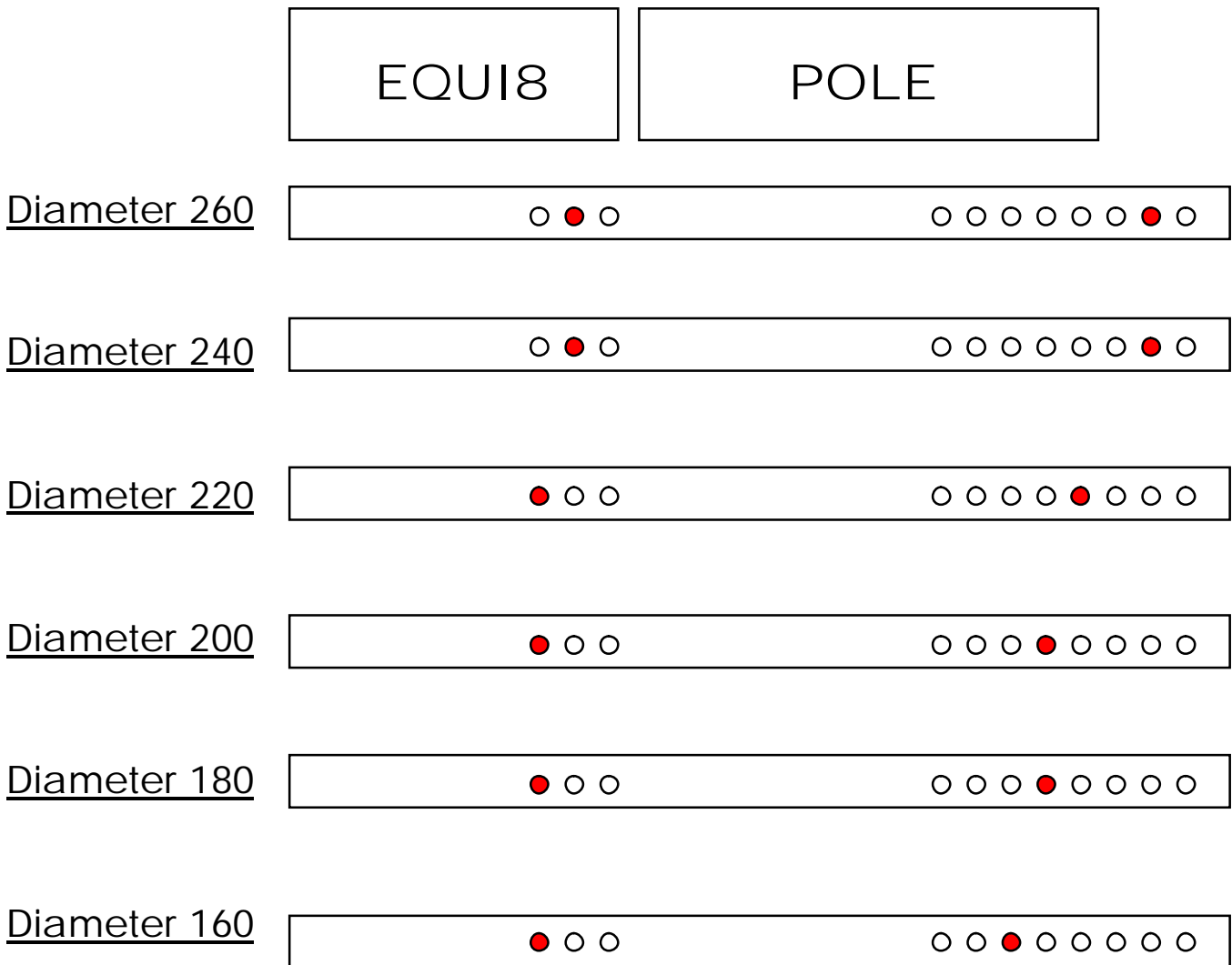

	INSTALLATION MANUAL	N° NT	NT-EQUI8
	EQUI8	Version	EN-A2
	Three-Phase Low Voltage Network Balancer	Page	12/17

B. EQUI8 lifting safety instructions

1. EQUI8 lifting requires 2 operators fable to lift together a 53 kg load.
2. Wear safety footwear, gloves and safety helmet to install EQUI8.

- The 2 operators should avoid putting their hands on the areas marked in red on the bottom view of EQUI8 (see picture below for rectangular section poles and next page for circular section poles), to prevent from squeezing their fingers. They should also avoid lifting EQUI8 by holding the removable bottom plate (marked in black on the picture below and in white on the picture next page).
- In order to lift EQUI8 safely, the 2 operators should make sure that they bend their legs and keep their back straight. The diagram below shows exactly what should not be done :

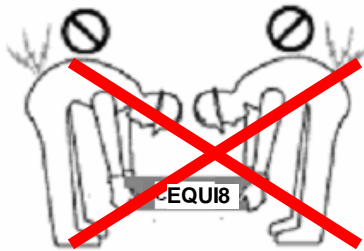

C. EQUI8's installation on a pole

- Once EQUI8 lays on the mounting kit, fasten it on the pole using metal strip (20x0,7) through the 2 back flanges.

Rectangular Section Poles

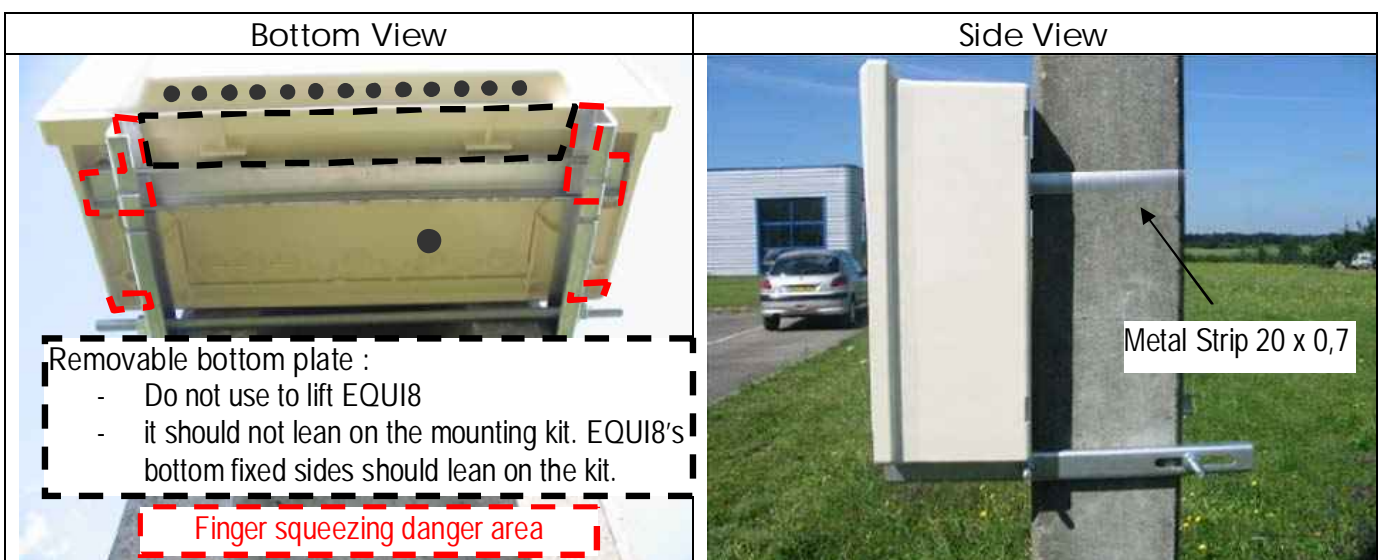

	INSTALLATION MANUAL	N° NT	NT-EQUI8
	EQUI8	Version	EN-A2
	Three-Phase Low Voltage Network Balancer	Page	13/17

Sur poteau bois de section circulaire

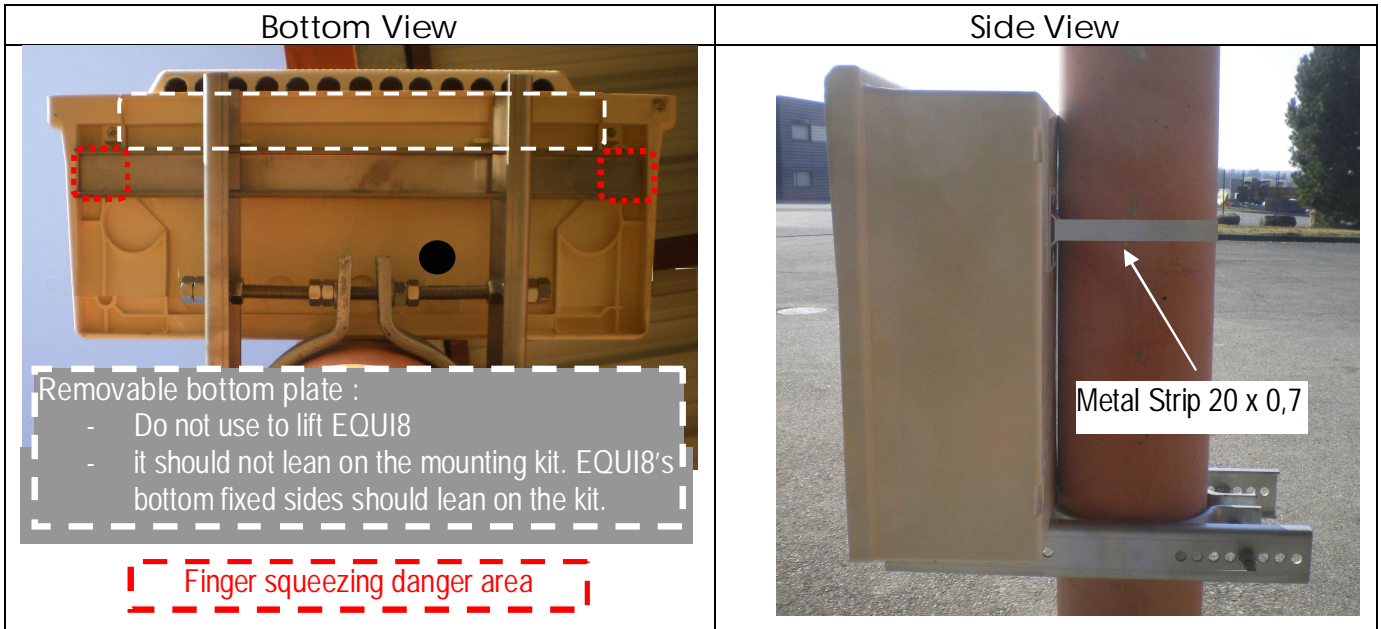

D. EQUI8's installation on a base

EQUI8 and its base have each 4 holes ready for bolt assembly (see © on picture below).

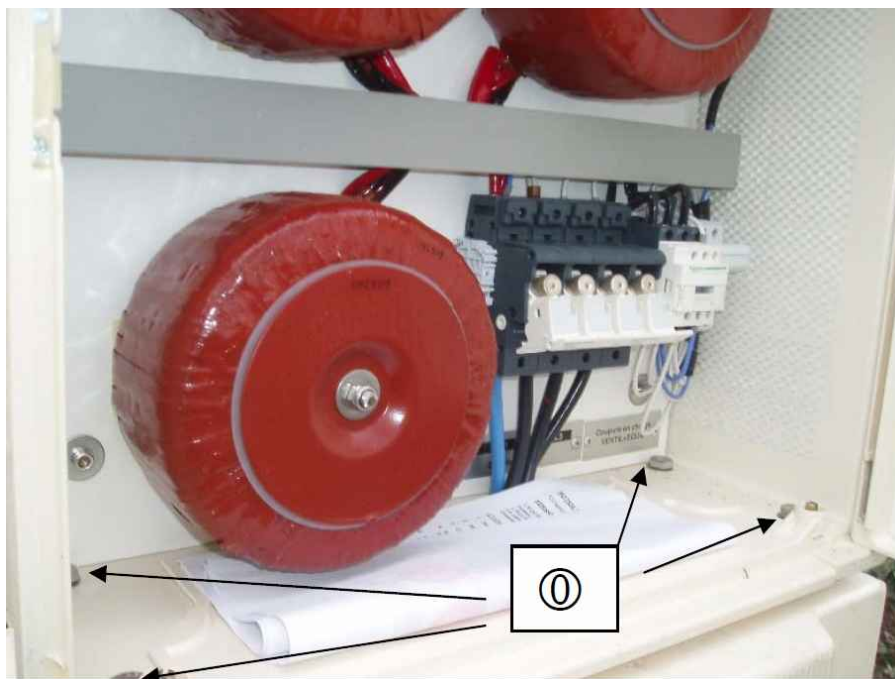

	<h1>INSTALLATION MANUAL</h1>	N° NT	NT-EQUI8
	<h2>EQUI8</h2>	Version	EN-A2
	<i>Three-Phase Low Voltage Network Balancer</i>	Page	14/17

1. Dig a hole for EQUI8's base : L 80 x W 50 x D 90 cm
2. Dig a trench towards the existing network dispatching cabinet or towards the buried network.
3. Mount the 4 legs on EQUI8's base. The height of legs can be optimized so that actual ground level is 2 cm below EQUI8's base removable door bottom (see **the red line on pictures below** and not the white line that corresponds to standard ground level marked on EQUI8's base).
4. Install EQUI8's in the hole. Lay connecting cable and D100 mm sleeve from network to EQUI8 in the hole. They should go in EQUI8's base vertically.
5. Fill up the trench from network to EQUI8's base's hole or install a temporary shuttering if the trench can not be filled up yet.
6. Pour a concrete foundation in the hole to lock EQUI8's base in the ground. Concrete should reach and not go above the **red line defined in point 3** above.
7. Do not install EQUI8 until the concrete has cured. Use the 4 bolts as shown on the picture on previous page (see ©).



	INSTALLATION MANUAL	N° NT	NT-EQUI8
	EQUI8	Version	EN-A2
	Three-Phase Low Voltage Network Balancer	Page	15/17

E. EQUI8's connection to the network

Safety Instructions :

Standard Personal Protective Equipment for use on Low Voltage public networks should be worn (conforms to EN-60903), i.e. at least:

Safety Helmet, Face Shield, insulated gloves (U<500V, Cat. M)

The numbers below (①, ②, ③...) refer to the connecting diagram on page 17.

- Open the load break switch (1P+N fuse holder marked "VENTIL+EQUI8" ①).
- Open the main 3P+N fuse holder (②).
- In the hole at the bottom of the enclosure (③), install a cable sleeve D30 mm (not included) with the cable* connecting to the network inside . The cable sleeve should have a hole at its lowest point to prevent raining water to flow in the enclosure.

* : For Alu cables, the use of Insulation piercing end connector type EBCP35M-16 is compulsory.

- Connect the connecting cable to the main 3P+N fuse holder (②). Make sure that bare wires do not exceed 13 mm to ensure IP2X rating on the main fuse holder.
- Connect the cable to the LV network (④).
- Close the Main 3P+N fuse holder (②).
- To start EQUI8, close the load break switch (fuse holder 1P+N VENTIL+EQUI8 ①).
- Check Voltage between phases (~400 V) on the 3 upper terminals of the 3P relay (⑤).
- Lock the door.

	INSTALLATION MANUAL	N° NT	NT-EQUI8
	EQUI8	Version	EN-A2
	Three-Phase Low Voltage Network Balancer	Page	16/17

IV. How to change fuses

Safety Instructions :

Standard Personal Protective Equipment for use on Low Voltage public networks should be worn (conforms to EN-60903), i.e. at least:

Safety Helmet, Face Shield, insulated gloves (U<500V, Cat. M)

The numbers below (1, 2, 3...) refer to the connecting diagram on page 17.

- Open the load break switch (1P+N fuse holder marked "VENTIL+EQUI8" ①).
- Open the main 3P+N fuse holder (②).
- Measure the resistance between the 3 upper terminals of the relay (⑤) and the upper neutral terminal of the main fuse holder (②): it should be approximately 320 mΩ. **If it is not the case, please call our customer service for support before connecting EQUI8 back to the network.**
- Check and replace if necessary the cartridge fuses :

Main fuse holder (②)	NEUTRAL: 1 cartridge fuse 14x51 - 40 amp type AM PHASE : 3 cartridge fuses 14x51 - 20 amp type AM
Load Break VENTIL+EQUI8 fuse holder (①)	1 cartridge fuse 10x38 - 2 A type GG

- Close the main 3P+N fuse holder (②).
- To start EQUI8, close the load break switch (fuse holder 1P+N VENTIL+EQUI8 ①).
- Check Voltage between phases (~400 V) on the 3 upper terminals of the 3P relay (⑤).
- Lock the door.

V. EQUI8's connection diagram

